



USER MANUAL

HS268M SMALL FOLDING SCOOTER



TABLE OF CONTENTS

01.INTRODUCTION	1
02.IMPORTANT PRECAUTIONS	2
2-1 BEFORE DRIVING SCOOTER	2
2-2 CAUTIONS WHEN DRIVING	3
2-3 CAUTIONS WHEN FOLDING / UNFOLDING SCOOTER	4
2-4 CAUTIONS WHEN DRIVING ON INCLINE	5
2-5 CAUTIONS WHEN CLIMBING	6
2-6 ELECTROMAGNETIC INTERFERENCE AND WARNINGS	6
2-7 SAFETY WARNING AND INSTRUCTION LABELS	8
03.IDENTIFICATION OF PARTS	9
04.INTRODUCTION & OPERATION OF SCOOTER.....	10
4-1 IDENTIFICATION & OPERATION OF CONTROL PANEL	10
4-2 OPERATION OF MAIN SWITCH	11
4-3 OPERATION OF THROTTLE LEVER	11
4-4 OPERATION OF FREE-WHEELING (N-D LEVER)	12
4-5 TILLER HEIGHT ADJUSTMENT	12
4-6 SEAT ADJUSTMENT / DISMANTLE	12
05.FOLDING / UNFOLDING YOUR SCOOTER	13
06.BATTERY GAUGE & CHARGING THE BATTERIES	14
6-1 DISASSEMBLING BATTERY BOX	14
6-2 CAUTIONS FOR BATTERY & CHARGER	15
6-3 BATTERY GAUGE	16
6-4 OPERATING THE CHARGER	17
07.CARE AND MAINTENANCE	19
7-1 INSPECTION CHECKS	19
7-2 CLEANING AND MAINTENANCE	20
08.TROUBLE SHOOTING	21
09.OTHER INFORMATION	23
9-1 OPTIONS	23
10.TECHNICAL SPECIFICATIONS	25

1. INTRODUCTION

Thank you and congratulations on purchasing your new Aspire mobility scooter.

It is designed to provide the transportation ability indoors and outdoors for person whose ability to walk is impaired, but who are still in terms of their eyesight and physically and mentally able to operate an electric scooter.

We pride ourselves on providing safe and comfortable products. Our goal is to ensure you complete satisfaction. We sincerely hope you enjoy your Aspire mobility scooter.

Please read and observe all warnings and instructions provided in owner's manual before you operate the various functions of this scooter. Also, please retain this booklet for future reference.

MANUFACTURED AND IMPORTED BY:

AIDACARE PTY LTD.

Building 3A, 1 Moorebank Avenue,

Moorebank NSW Australia 2170

1300 133 120 | www.aspirecare.com.au

2.IMPORTANT PRECAUTIONS

2-1 BEFORE DRIVING SCOOTER

- Before take the first trip with mobility scooter, you should familiarize yourself well with the operation of mobility scooter and with the operation elements. Please take your time to read this introduction booklet.
- Before driving, please evaluate the personal condition, and fully understand the operation of mobility scooter.
- Before charging the scooter, please release the Circuit Breaker on battery box first to activate the system (see section 3)
- Scooter is shipped with 30% of battery charge only, batteries should be fully charged before your journey for maximum performance and longevity (see section 6).
- Scooter is equipped with certain type of battery (lithium or optional lead-acid), if you want to change it, please contact dealer to reset the battery system such as charging port and controller setting. Only one type of batteries can be used on scooter, do not mix the batteries and charge, or it may result dangers
- The maximum load of the scooter is 115KG. Do not exceed the maximum permissible load. Exceeding the max.weight rating may result in injury to yourself.
- The mobility device is only designed for use by a single occupant whose maximum weight does not exceed the maximum permissible load of the device. Never use the mobility device to transport more than one person (including children).
- You should not assemble, maintain, and operate the mobility scooter before you read this instruction booklet.
- Do not attempt to modify or dismantle the battery box or carry out any maintenance work that is not described in this user manual.
- Do not change, modify, remove any parts (seat, shroud) from products especially safety protected parts such as anti-tippers.
- Materials and assemblies of scooter are flame resistant.
- Always keep battery box installed on scooter to avoid short-circuit, do not attempt to remove battery box at all possible.
- Always keep the tiller screw knob fasten at whole time except when adjusting the tiller height.
- Do not sit or stay on scooter when scooter is on moving transport vehicles to avoid dangers
- Turn the power off before getting on or off. (see section 4-2)
- Do not drive your scooter if you are under the influence of alcohol or medication that may affect your ability.
- Do not turn off the power while driving. Doing so will bring the scooter to an abrupt stop and danger.
- Please observe all relevant rules and regulations pertaining to pedestrians and road users at all times when you are driving the scooter.
- Mobility device may only be used on the traffic routes for which it is approved in accordance with the relevant national legislation.
- Always be aware of pedestrians and situations which might require extra care when using your scooter on public walk ways and footpaths.
- Avoid driving scooter in dark or in conditions of bad weather and visibility for safety



- Do not turn the power on before you get in and sit securely on the seat.
- Be certain that the power is turned off when get in, get out. This will eliminate the possibility of accidentally activating the wigwag controls and causing injury.
- Keep your weight toward the middle of the deck. Putting most or all of your weight on the edge of the deck may cause an unstable condition.
- Do not use hose pipe or splash water directly onto the scooter or store the scooter in a humid condition such as rain or show as this may cause damage to electronics.
- Do not remove safety protected parts such as anti-tipper from scooter.
- Do not use the unauthorized parts such as battery or charger on the scooter. Use the accessories supplied from original dealer only.
- Do not exceed the maximum permissible load of scooter or it may cause unbalance.
- Please stop operating the scooter and contact your dealer if you find the sign of scooter malfunction.
- Please pay more attention when driving the scooter, the emergency stop may encounter (ex. scooter malfunction, out of power, over-voltage, EMI interference)

Practice Tips :

- If you are new to driving a scooter, it is a good idea to practice in a clear, safe space on an flat level surface. (I.e. Park, Playground).
- Basic functions to practice : Wig wag accelerate / Wig wag release / Stop / Reverse / Turn / Ramp proceeding.
- Set the speed control to its lowest speed, slightly increase the speed when you are getting familiar with the scooter.



- Practice operating your scooter in the presence of an attendant. Remember that only with practice will you become a competent driver.
- Practice these basic functions until you feel that you have control of your scooter.



Accessories Contents for Your Scooter :

- Auto-folding version : remote control x 1
- Manual-folding version : key x 2

2-2 CAUTIONS WHEN DRIVING

- Please do the daily check before your journey always. (See section 7-1)
- Do not stretch your body out on the scooter.
- Do not use the mobile phone and wireless mobile devices while driving.
- Do not use the batteries of mobility scooter to charge any other electric devices, except the accessories from original manufacturer.
- Do not drive on a slope which is over the limit. (See section 2-4)
- Please bypass, do not drive to across the obstacle over the limit (See section 2-5)
- Do not attempt to drive the scooter under below hazardous road condition. If necessary, please drive it in the presence of an attendant :
 - Dark, bad weather such as in rain, snow, mist, storm, and poor visibility.
 - Narrow paths, level crossing, and uneven terrain.
 - Wet grass, sand, gravel, or any other potentially hazardous condition.

- Please stop operating the scooter if the batteries have drained, continuous operation may damage the scooter.
- Do not drive when the seat lock is positioned in folding point (red). Scooter can be operated only when the seat lock is in the fixation point (green). (see section 4-6)
- When turning, reduce your speed and maintain a stable center of gravity. This greatly reduces the possibility of a tip or fall.
- Do not bounce or jam on the footplate.
- Please always set the speed control to its lowest speed when you start to drive, and observe all relevant rules and regulations pertaining to pedestrians and road users at all times.



- Reduce speed when descending to prevent any danger. Increase speed when ascending (see section 2-4)
- Do not turn off the power while driving.
- Do not operate on staircases or escalators.
- Do not attempt to climb curbs greater than limitation show on Technical Specification.
- Do not make S turns or sharp turns while driving. This may cause the scooter to tip.
- Never place the scooter in freewheel mode (Neutral) on any sort of an incline or decline to avoid rollaway. .
- When the scooter is parked, the lever for engaging and disengaging the motors must be locked firmly into the “DRIVE” position. (see section 4-4)
- Do not conduct any adjustment such as tiller / light setting / control panel setting while driving.
- Do not pull the seat springs while driving to avoid dangers. (see section 4-6)

2-3 CAUTIONS WHEN FOLDING/UNFOLDING SCOOTER

- When folding or unfolding, you must place the scooter on a flat ground to avoid tip-over, rollaway, or dangers. Never operating the folding/unfolding process on a slope
- Please read through the section 5 for folding / unfolding operation before you operate the scooter.
- Turn off the power before you fold / unfold the scooter. (see section 4-2)
- Folding/unfolding actions will stop if any malfunctions are detected.(see section 8)
- Please make sure the lever for engaging and disengaging the motors must be locked firmly into the “DRIVE” position before you fold / unfold the scooter. Never proceed the folding/unfolding under freewheel mode “Neutral” position (see section 4-4)
- Scooter can be charged when it’s folded or unfolded. However, scooter will not respond to folding / unfolding commands when charger is plugged. To operate the folding / unfolding, please unplug the charger from the scooter (see section 6-4).
- Please remove all the accessories, such as armrests or bags out before folding / unfolding the scooter
- Please observe environment surround you for safety before folding/unfolding the scooter.
- When the folding or unfolding is processing, please pay attention to the movement of tiller for your safety.
- When the folding or unfolding is processing, do not sit or interrupt the process or it may cause damage or danger to the scooter and yourself.
- Please double check and make sure the procedure of folding / unfolding is completed before you get on the scooter.



- Do not turn on the power when the scooter is folded.
- Scooter can be rolled by front wheels and supporting castors when it's folded (refer to Right picture).
- Do not sit or stay on folded/unfolded scooter when scooter is on moving transport vehicles.
- Do not store the scooter in a humid condition such as rain or show as this may cause damage to electronics. (see section 7-2)
- The brake does not apply when the scooter is in folded and standing position. Do not place the standing folded scooter on a slope to avoid roll-away and danger (Fig.1)
- When folding or unfolding, you must place and lay down the scooter on a flat ground (Fig. 2)

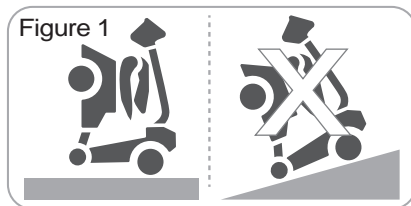

• Do not place scooter on a slope when scooter is folded and standing.

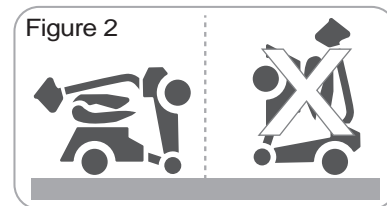

• Place and laydown the scooter before unfolding.



Do not drop the folded scooter when it is in standing or laying down position.

2-4 CAUTIONS WHEN DRIVING ON INCLINE

- The scooter has been rated to a maximum climbable height, obstacle height, and gap. (see section 10)
- Never drive on a slope that exceeds the rated slope.
- For maximum stability, lean forward in your body while proceeding up ramps, inclines, curbs, or any low rise. (please refer to following picture)



On flat road



On slope



115kg / 6 degree

- The weight capacity limit is 115kg at 6 degree ramp (please refer to above picture).
- Your scooter's ability to travel up inclines is affected by your weight, your scooter's speed, your angle of approach to the incline, and your scooter setup.
- Please avoid to driving on a long ramp or any uneven terrain to prevent any danger from motor defected.



- When driving down a ramp or uneven terrain, keep the scooter's speed adjustment set to the slowest to ensure a safely controlled driving.
- If the speed is too fast, release the throttle control lever, let the scooter stop. When you feel that you again have control of your scooter, push the throttle control lever forward and continue safely driving.
- To prevent any danger, do not make turns on ascending, descending ramp.



- Drive close to roadside when descending. The batteries voltage normally will go up when driving on descending road. If the battery voltage becomes too high, the over-voltage protection will be activated by slowing the speed till the scooter stops (error light indicator will flash 3 times). Release the wigwags and restart the scooter again.
- Drive the scooter along the roadside while going uphill. The motor might be over-heating when overloaded. The protection system will be activated by slowing the speed till the scooter stops in order to prevent damage the motor. Turn off the main power then wait for at least 15 minutes to restart the scooter.

2-5 CAUTIONS WHEN CLIMBING

- The maximum climbing angel is 6 degree.
- The maximum height of obstacle and curb that scooter can climb is up to 50 mm (A).
- The maximum gap that scooter can drive over is 100mm (B).
- When driving scooter on ramp, adjust body center of gravity for scooter stability (see section 2-4).

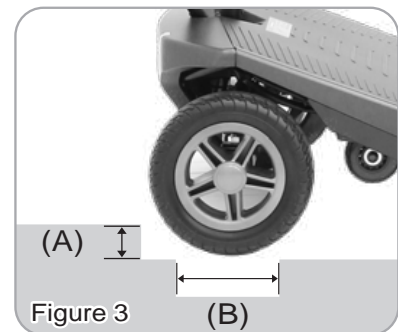

Figure 3



Even though your scooter has been rated with maximum climbable, we suggest not driving through an obstacle.

2-6 ELECTROMAGNETIC INTERFERENCE AND WARNINGS



It is very important that you read this information regarding the possible effects of Electromagnetic Interference on your mobility scooter.

Mobility scooters may be susceptible to electromagnetic interference (EMI), which is interfering electromagnetic energy (EM) emitted from sources such a radio stations, TV stations, amateur radio (HAM) transmitters, two-way radios, and mobile phones. The interference (from radio wave sources) can cause the mobility scooter to release its brakes, move by itself, or move in unintended directions. It can also permanently damage the mobility scooter control system. The intensity of the interfering EM energy can be measured in volts per meter (V/m). Each mobility scooter can resist EMI up to certain intensity. This is called its "immunity level." The higher the immunity level, the greater the protection. At this time, current technology is capable of achieving at least a 20 V/m immunity level, which would provide useful protection from the more common sources of radiated EMI. The immunity level of this mobility scooter model is not known.

There are a number of sources of relatively intense electromagnetic fields in the everyday environment. Some of these sources are obvious and easy to avoid. Others are not apparent and exposure is unavoidable. However, we believe that by following the warnings listed below, your risk to EMI will be minimized.

The sources of radiated EMI can be broadly classified into three types :

1. Hand-held portable transceivers (transmitters-receivers) with the antenna mounted directly on the transmitting unit. Examples include: citizens band (CB) radios, "walkie talkie," security, fire, and police transceivers, mobile phones, and other personal communication devices.



Some mobile phones and similar devices transmit signals while they are ON, even when not being used

2. Medium-range mobile transceivers, such as those used in police cars, fire trucks, ambulances, and taxis. These usually have the antenna mounted on the outside of the vehicle; and
3. Long-range transmitters and transceivers such as commercial broadcast transmitters (radio and TV broadcast antenna towers) and amateur (HAM) radios.



Other types of hand-held devices, such as cordless phones, laptop computers, AM/FM radios, TV sets, CD players, and cassette players, and small appliances, such as electric shavers and hair dryers, so far as we know, are not likely to cause EMI problems to your mobility scooter.

Mobility Scooter Electromagnetic Interference :

Because EM energy rapidly becomes more intense as one moves closer to the transmitting antenna (source), the EM fields from hand-held radio wave sources (transceivers) are of special concern. It is possible to unintentionally bring high levels of EM energy very close to the motorized scooter control system while using these devices. This can affect mobility scooter movement and braking. Therefore, the warnings listed below are recommended to prevent possible interference with the control system of the mobility scooter.

Warnings :

Electromagnetic interference (EMI) from sources such as radio and TV stations, amateur radio (HAM) transmitters, two-way radios, and mobile phones can affect mobility scooters. Following the warnings listed below should reduce the chance of unintended brake release or mobility scooter movement which could result in serious injury.

1. Do not operate hand-held transceivers (transmitters-receivers), such as citizens band (CB) radios, or turn ON personal communication devices, such as mobile phones, while the mobility scooter is turned ON;
2. Be aware of nearby transmitters, such as radio or TV stations, and try to avoid coming close to them;
3. If unintended movement or brake release occurs, turn the mobility scooter OFF as soon as it is safe;
4. Be aware that adding accessories or components, or modifying the mobility scooter, may make it more susceptible to EMI; and



There is no easy way to evaluate their effect on the overall immunity of the mobility scooter.









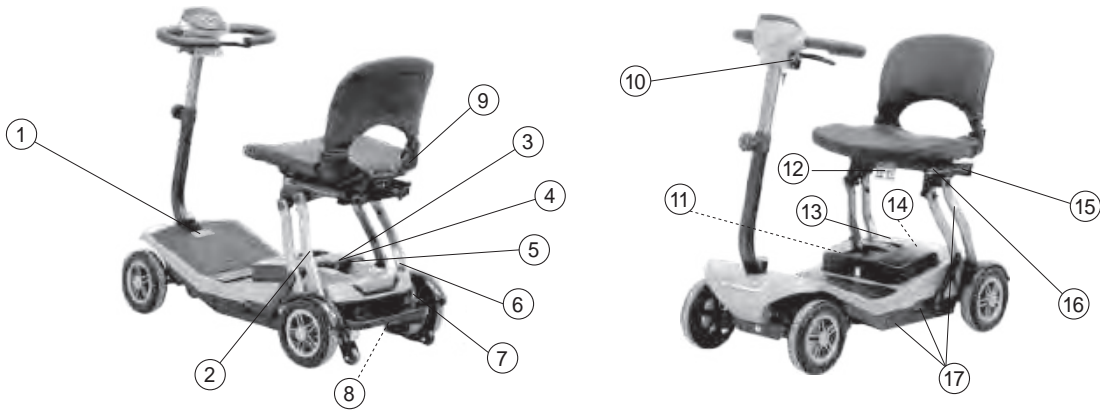





5. Report all incidents of unintended movement or brake release to the distributor listed on the inside front cover of this manual. Note whether there is a source of EMI nearby.

Important Information :

1. 20 volts per meter (V/m) is a generally achievable and useful immunity level against EMI (as of May 1994). The higher the level, the greater the protection.
2. The immunity level of this product is at least 20V/m.

2-7 SAFETY WARNING AND INSTRUCTION LABELS

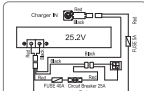

<p>1</p> 	<p>Warning Sticker</p> <ol style="list-style-type: none"> 1. Please read the instruction booklet carefully before using your scooter. 2. Keep the scooter properly maintained. 3. Do not drive the scooter on slippery surfaces or on slopes over 6°. 4. Do not drive on highway, crowded roads, or unfamiliar areas. 5. Do not turn at high speed in either forward or reverse. 6. Do not wash with water or leave scooter in humid environment since water can damage the electronic parts. 7. Always re-engage the emergency freewheel drive after use 8. Weight restriction of the device : 255 lbs 9. Do not operate on staircases or escalators. 		
<p>2</p> 	<p>Scooter information label States the date of manufacture and serial number of the scooter. This product has been supplied from an environmentally aware manufacturer. It may contain substances that could be harmful to the environment. Recycling must be carried out in accordance with the respective national legal provisions.</p>		
<p>3</p> 	<p>Power warning label</p>	<p>11</p> 	<p>Seat position warning plate Do not get on the scooter if the seat is not fixed. Push the seat forward until the seat locks to its position (green), you will hear a click sound.</p>
<p>4</p> 	<p>Instruction of battery lock nut (circuit breaker) label</p>	<p>12</p>  <p>Manual Version Only</p>	<p>Folding / unfolding instruction label</p>
<p>5</p> 	<p>Battery charging warning label</p>	<p>13</p> 	<p>Safety instruction label of Lithium battery : Read carefully to prevent improper operation.</p>
<p>6</p> 	<p>N-D Lever Adjustment label Instructs freewheel mode operation. (see section 4-4)</p>	<p>14</p> 	<p>Fixation point reminder Sit only when the seat slide is fixed to green point</p>
<p>7</p> 	<p>Heat caution warning label Be aware that the motor may normally become hot during operating. Please avoid skin contact.</p>	<p>15</p> 	<p>Seat position indication label Seat latch is locked when the seat positioned in green. Seat latch is released when the seat positioned in red. Do not sit if seat is positioned in red</p>
<p>8</p> 	<p>Pinch point warning label Keep hands away</p>	<p>16</p> 	<p>Pinch point warning label Keep hands away</p>
<p>9</p> 	<p>Charge port cap sticker</p>	<p>10</p> 	<p>Wiring diagram for batteries</p>

3. IDENTIFICATION OF PARTS



Figure 4

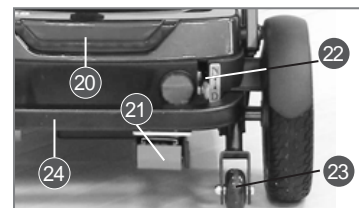
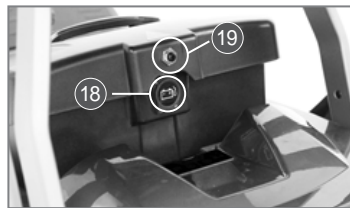
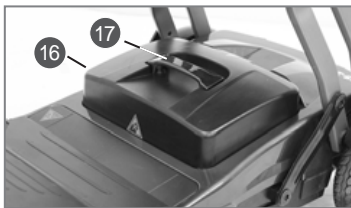
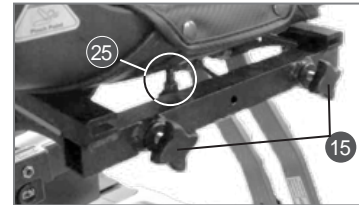
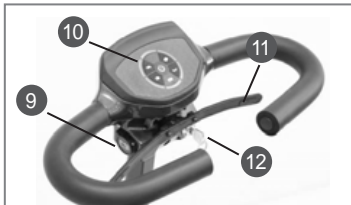

No.	ITEM	No.	ITEM
01	Steering	14	Seat Backrest
02	Tiller Height Adjustment	15	Seat Knob
03	Head Light	16	Battery Box
04	Front Wheels	17	Battery Box Handle
05	Footplate Cover	18	Charging Port (battery box)
06	Seat Springs	19	Circuit Breaker (press when charging scooter for the first time and when releasing the over-voltage protection)
07	Supporting Wheels	20	Tail light / Brake light
08	Rear Wheels	21	Folding/unfolding release lever
09	Charging Port (upper)	22	N-D Lever
10	Control Panel	23	Anti-Tippers
11	Throttle Lever	24	Rear bumper
12	Key Switch	25	Seat Screw
13	Seat		

*Above is only for reference, actual product may vary.

4.INTRODUCTION & OPERATION OF SCOOTER

4-1 IDENTIFICATION & OPERATION OF CONTROL PANEL

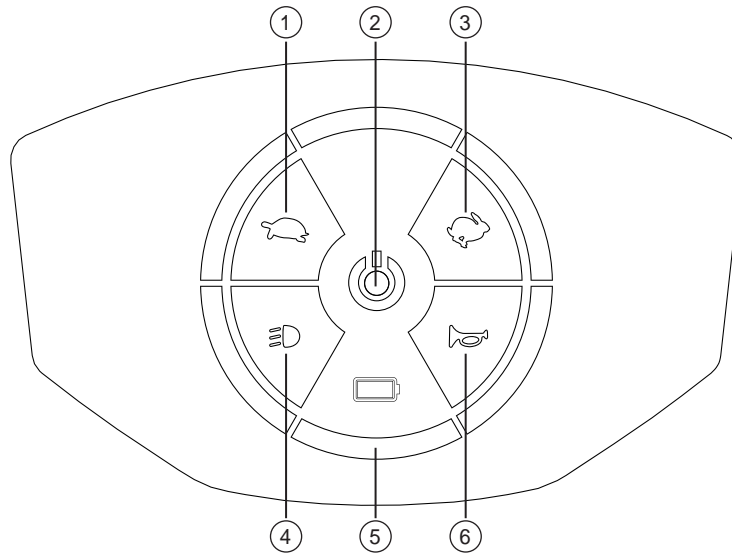



Figure 5 - HS-268 Control Panel

No.	ITEM	FUNCTION
1	Speed Deceleration	Press to decrease speed
2	Power on / Error Light Indicator	Showing power on or errors
3	Speed Acceleration	Press to increase speed
4	Head-light / Tail-light Switch	Press to turn on headlight and taillight.
5	Battery Gauge	Showing battery status
6	Horn	Press to sound warning tone when necessary

-  • Please keep the panel clean, away from water, oil, and dust as the RF reading range may be reduced or malfunction may result.
- When operating the panel, always press on the center of the button to ensure the button press is detected.
- Do not place any objects on the panel or it may disrupt the touch screen or cause damage to the scooter.
- Battery / Error Indicator will be flashing if there is error, please stop operating the scooter if indicator is flashing (see section 8).
- If the power button continues lightening after power off, please release the throttle control lever and remove the battery pack. Please contact your dealer.

Power On / Error Light Indicator :

- Power light on – See section 4-2 for details
- Error light on – See section 8 for details

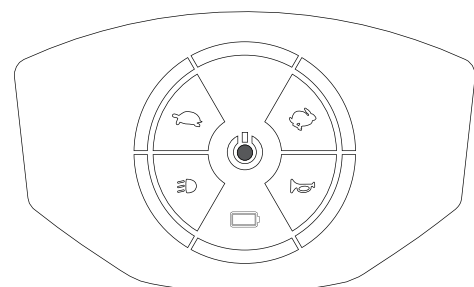



Figure 6

Speed Adjustment :

- Press acceleration [] / deceleration [] button to increase / decrease speed.
- There are 3 different speeds of adjustment fastest 3>2>1 slowest. (Figure 7)

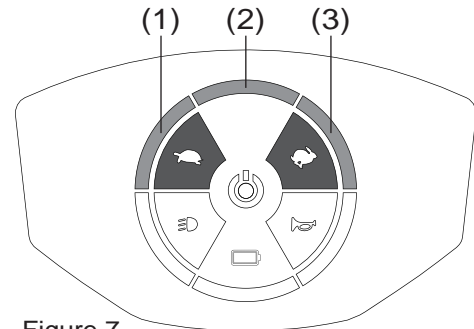





Figure 7



- Do not set the speed at maximum when operating the scooter.
- Adjust the speed at maximum when inclining a slope, and adjust to minimum speed when declining.

Head-light / Tail-light :

- Press button [] once to switch on the head-light and tail - light, the [] will be lighted on the panel. light will be off on the panel (figure 8)
- Switch off by pressing the button again, the [] light will be off on the panel (figure 8)

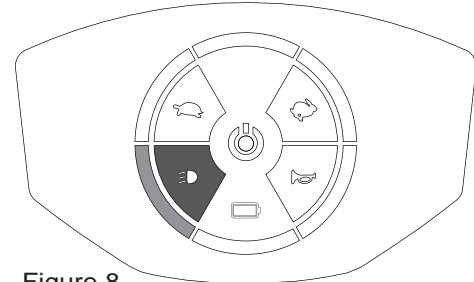

Figure 8



Tail-light will be on anyway when the brake is engaged and when the scooter speed is reduced.

Horn :

Press horn button to sound the buzzer. Buzzer sound and light will last until you release the horn button (Figure 9)

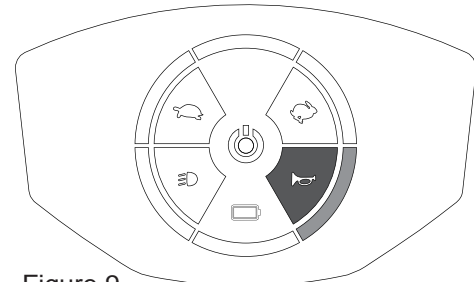

Figure 9

4-2 OPERATION OF MAIN SWITCH

Main Switch (Touch Screen Version) :

- Press power button to turn on/off (Figure 10) (see section 4-1 for details)

Main Switch (Key Version) :

- Turn the key clockwise to turn on, counterclockwise to turn off (Figure 11)

Sleep Mode :

- Scooter will go into sleep mode with one long beep warning sound if no throttle lever activity is detected for programmable time period. (Default programmable time is 10 mins.)
- When scooter is in sleep mode, all lights on the control panel will be off, and the scooter will not respond to commands.
- To wake up the scooter, turn the power off and then on again.

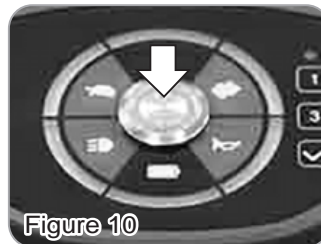

Figure 10



Figure 11

4-3 OPERATION OF THROTTLE LEVER

Throttle Lever :

- Pull the right throttle lever (F) to move scooter forward. Pull the left throttle lever (G) to move scooter backward. This can be reversed if required by local dealer. (Figure 12)
- These are also your accelerator. The further you depress them, the faster you go. (Subject to the level of speed adjustment)
- Releasing both left / right throttle levers will automatically operate the brakes to slow down and stop.

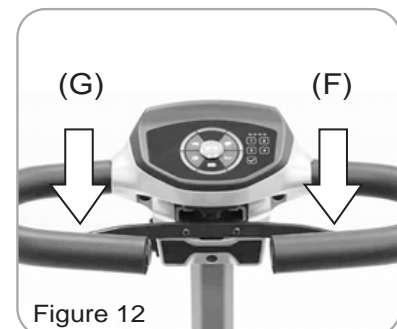

Figure 12



- Do not pull both right and left throttle lever at the same time; you might not be able to control the scooter.
- Turning the scooter OFF whilst driving will bring the scooter to an abrupt stop and danger.

4-4 OPERATION OF FREE-WHEELING (N-D LEVER)

Free-wheeling (N-D Lever) :

- When lever is in Drive (D) position, the scooter can be driven. Normal position is in D (Figure 13)
- When lever is Neutral (N) position, the scooter can be moved manually without power (Figure 14)

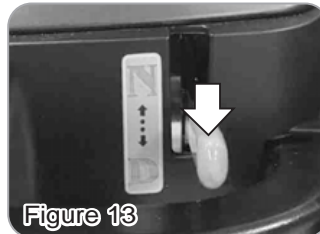

Figure 13

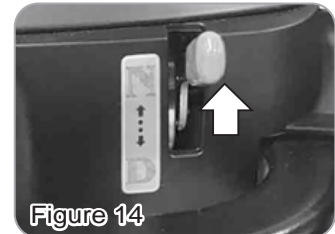

Figure 14



- Freewheel operation is only recommended on flat surfaces. Never leave your scooter on gradient with its motors disengaged.
- When adjusting N-D lever, do not sit on the scooter.
- It's not able to drive the scooter when the lever is in Neutral. You must turn off the scooter first and switch to D lever, then turn on and drive scooter.

4-5 TILLER HEIGHT ADJUSTMENT

Loosen (counterclockwise) the screw knob to adjust the tiller height, tighten (clockwise) screw knob again to lock at a desired position.

There is a stop point on tiller, the height cannot exceed the stop point (approx. 20cm) (Figure 15)

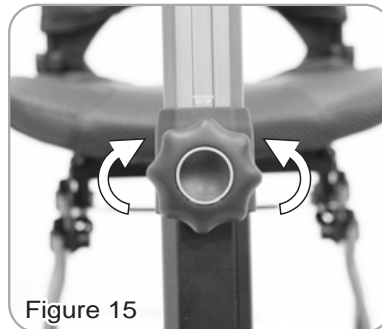
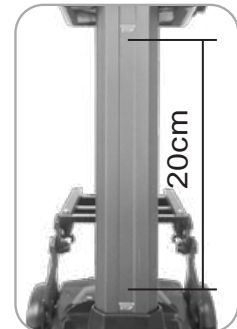

Figure 15



4-6 SEAT ADJUSTMENT / DISMANTLE

- Please refer to section 5 for scooter folding / unfolding.
- When scooter is being folding, the seat latch will automatically release and seat will move backwards.
- After unfolding, the seat shall automatically move forwards. However, please always double check and push the seat to its locked position) manually if not.
- Do not get on the scooter if the seat is positioned in red point(H).Get on the scooter only if the seat is locked in its position green point (Fig.16)

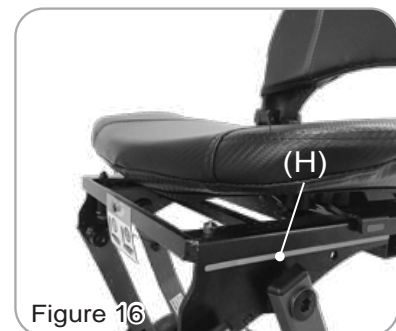
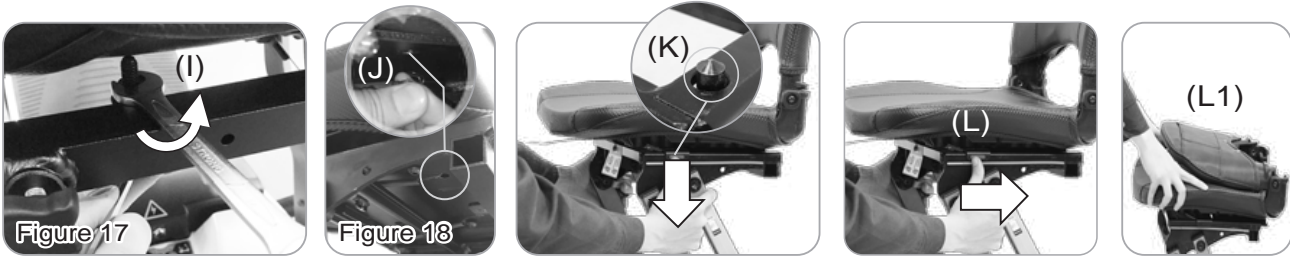



Figure 16

Seat Dismantle :

- 1.Loosen the screws (I) by wrench and hex key.
- 2.Press the springs (J) to remove from the seat slide bracket.
- 3.Pull down and hold the seat springs to release the seat latch (K).
- 4.Push the seat bracket (L) by thumbs towards the back of scooters to release the seat from latch.
- 5.When the seat is released from latch, grab the seat (L1) and push it towards the back of scooter to remove the seat.

- ※ When putting the seat back, insert the seat back to seat slide bracket. Push the seat towards to the front of scooter (green point), fasten the screws (Fig.21) and insert the springs back to seat slide bracket (J).
- ※ Please make sure to follow the direction of Step 2 (Fig. 18). shown when putting springs (J) back to the bracket. Otherwise, it may cause damage.



-  • Do not conduct any adjustment (tiller / seat / armrest) while driving the scooter.
- Do not get on the scooter until the seat firmly locks in the position (green point).
- Except for removing seat, do not operate the seat sides spring if no necessary.
- When pulling the seat springs, please grab and hold down both sides springs, this helps user to easily release the seat latches. The latches may not be released if the holding point of seat springs is incorrect.
- If there is any defect on spring, please contact your dealer.

5.FOLDING / UNFOLDING YOUR SCOOTER

Folding / unfolding your scooter only when the scooter is under below circumstances :

- When the scooter is placed on a flat ground.
- When the seatback is flip down.

How to fold the scooter (Figure 19) :

1. Turn off the power and flip down the seat back.
2. Take hold of seat and push backwards simultaneously when pulling the release lever with the other hand.
3. After pulling the release lever, push the seat forwards. The supporting wheels will touch the ground when the release lever is successfully triggered.
4. Hold the handle bar and pull the tiller downwards.
5. Push the tiller down until you hear the click sound.
6. Pull up the folded scooter. Scooter can be carried around or rolled by front and supporting wheels now.



Figure 19

How to unfold the scooter (Figure 20) :

1. Place the scooter to a flat ground and lay down the scooter. Make sure the rear wheels lay on the ground before unfolding the scooter.
2. Push down the tiller then pull the release lever.
3. Pull the tiller upwards until the front wheels touch the ground.
4. Use one hand to hold the rear frame and the other hand to list up the seat to make the scooter fully expand.
5. Slide the seat forwards to the green point to lock the seat. You will hear a click sound when the seat is locked to its position.
6. Flip up the seatback and double check if lock is all in its position before you get on the scooter.

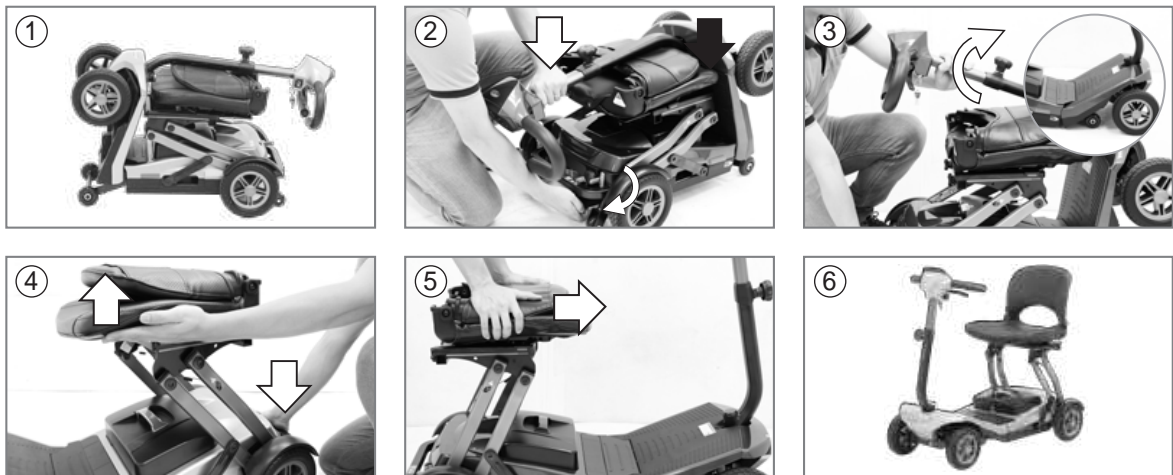

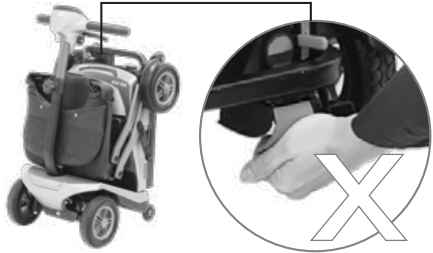

Figure 20



- Please turn off the power on the flat ground before folding / unfolding, the scooter can only be folding / unfolding when it is power off.
- Do not pull the lever when the scooter is folded and standing (refer to right picture).
- If there is any abnormality during folding/unfolding, the action will stop. (see section 8)
- Please make sure the N-D lever is switched to D position before folding / unfolding to avoid scooter sliding. (see section 4-4)



6.BATTERY GAUGE & CHARGING THE BATTERIES

6-1 DISASSEMBLING BATTERY BOX

- Each battery box contains one lithium battery or (2) lead-acid batteries (optional).
- The battery box is designed for a better stability. Please follow the instruction to disassemble the battery box (Figure 21). Push the battery backwards (1.) and pull it upwards (2.).
- It's highly recommended not to remove battery box out if no necessary. Always keep battery box installed on scooter.
- For any reason to remove the battery box, please make sure the connectors are in sequence and in position when put it back to scooter.

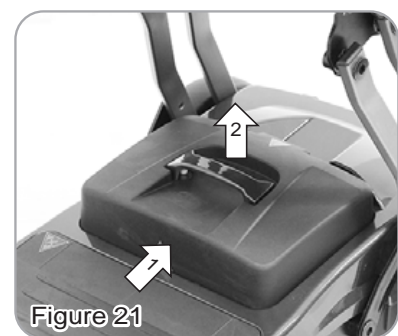

Figure 21



- When putting battery box back to scooter, gently press battery box downward to make sure it is firmly connected to the scooter.
- Do not disassemble battery box and open sealed parts by yourself to prevent electric shock and damage the battery.
- Maintenance & repair must only be carried out by a competent engineer or authorized dealer. Please contact dealer if you need to replace internal battery.

6-2 CAUTIONS FOR BATTERY & CHARGER

Lithium Battery :

- Only certain type and voltage of battery can be used on the scooter. Your scooter may supply with standard lithium battery or optional lead-acid battery.
- Scooter can be charged when it's folded or unfolded. Please turn the power when charging. (see section 4-2)
- Only use the lithium battery charger (2A/4A) supplied with your scooter for lithium battery.
- Do not switch off, unplug or interrupt the recharge cycle until the charging cycle has completed (charger indicator turns green)
- If storing your scooter for a prolonged period (1 month or more), storage the batteries at 30%-50% state of charge at least (voltage between: 25.2V~25.9V). Batteries must be recharged once every three months at least if storing for more than three months. On returning, make sure to charge them again before using scooter.
- Store the scooter in a dry, well-ventilated environment. Do not store your scooter where it will be exposed to source of direct heat, damp, water, oil, acid, alkaline, or where Ozone could be possibly generated. All of the above will minimize scooter's lifetime.
- Recommended range of storage : Temperature : 20-30°C, Humidity : 25% ~ 85%, out of this range might affect the performance of the charger and battery.
- Rough handling operations, throwing, rolling, crushing, shaking, overly strong impact and extrusion to batteries should be avoided, to prevent battery casing broken or internal structure damage.
- It's highly recommended to have your scooter inspected for battery every six month despite how often you use the scooter. Please contact your dealer.
- Batteries are subject to disposal and recycling regulations that vary by country and region. Always check and follow your applicable regulations before disposing of any battery.
- Please see number 14 safety instruction label of lithium battery in section 2-7 for more details.
- Manufacturer will not assume any liability or responsibility for any loss, damage or injury arising from or in respect of any misuse of the Lithium battery.

24V/12A Lead-Acid Battery (optional) :

- Only certain type and voltage of battery can be used on the scooter. Your scooter may supply with standard lithium battery or optional lead-acid battery.
- Only use the lead-acid battery charger (2A) supplied with your scooter for lead-acid battery
- Adding acid electrolyte to battery is prohibited
- Batteries will only give maximum performance after scooter has been used and batteries have been recharged several times.
- The minimum time needed to recharge will vary depends on the depletion of the batteries. Excessive or short period charging will be detrimental to battery life.
- Charge the batteries after each trip. Do not turn the power on while scooter is in charging.

- Please charge the scooter in 0°C ~ 40°C, out of this range might affect the performance of the charger and battery.
- If storing your scooter for a prolonged period, batteries must be recharged once every three months at least
- For longest life, your batteries should be recharged regularly. Please recharge the batteries before they run down to 20%.
- It's highly recommended to have your scooter inspected for battery every six month despite how often you use the scooter. Please contact your dealer.

Chargers(lithium / lead-acid) :

- Do not leave charger plugged into your scooter with charger switched off as this may discharge your batteries. Always unplug the cables when finishing charging.
- Inspect the battery charger before each use, make sure connectors are dry and clean. Do not attempt to use an extension cord to plug in your battery charger.
- Be aware that the battery charger case may become hot during charging. Please avoid skin contact.
- Do not cover charger by any objects. Use the charger in a well-ventilated area. Do not smoke as explosive gases may be generated while charging the batteries
- Keep the charger stored in a well-ventilated area, do not drop the charger.



- Lead-acid battery charger cannot be alternatively used on lithium battery. Please only use specific lithium battery charger for your lithium battery. Lead-acid battery charger can be used only if your scooter comes with lead-acid batteries (optional). (Please see section 9-1 for details)
- If you want to change to optional lead-acid batteries, please contact dealer to reset the battery system such as charging port and controller setting.
- Please keep the above cautions in mind. Any battery / charger faults due to the unauthorized maintenance, dismantle, misuse or accidental damage is not covered by the manufacturer's warranty.

6-3 BATTERY GAUGE

There is an indicator shows battery capacity status (Figure 22) :

- **Touch screen version : 6 segments**
- **Key Switch version : 5 segments**
- When battery gauge light trends to right (green), it indicates sufficient power capacity.
- When battery gauge light trends to left (red), it indicates insufficient power capacity.



- Check battery capacity before driving. Recharge the battery immediately when the red light is flashing as the remaining power can only keep scooter going for buffering 2 km or less
- Displayed segments on panel are for reference only. Please refer to LED indicator of charger for more accurate charging status.
- The scooter may not be able to fold/unfold when the battery capacity status is less than 3 segments, please recharge the battery immediately.



Figure 22

6-4 OPERATING THE CHARGER

Batteries must be charged before using the scooter for the first time and should be recharged after each day use.

Your scooter may come with standard lithium 24V/2A charger, or optional bigger 24V/4A charger if you upgrade the lithium battery to 17.4Ah . Your scooter may come with 24V/2A lead-acid charger if you optionally choose lead-acid battery for your scooter.

Do not alternatively use lead-acid charger to charge lithium battery, they are not compatible and may cause damages and dangers if doing so.

Lithium Battery Charger :

- Output Voltage: 100V~240V (Figure 29)
 - 1.Charger output cable, 4pins  connector (R)
 - 2.AC power cord (S)
 - 3.LED Indicator (T)
 - RED LIGHT ON : Pre-charging
 - ORANGE LIGHT ON : Normal Charging
 - GREEN LIGHT ON: Fully Charged.
 - 4.2A charger takes 7 hours and 4A charger takes 5 hours for a full charge. Remove the AC plug first after charging.

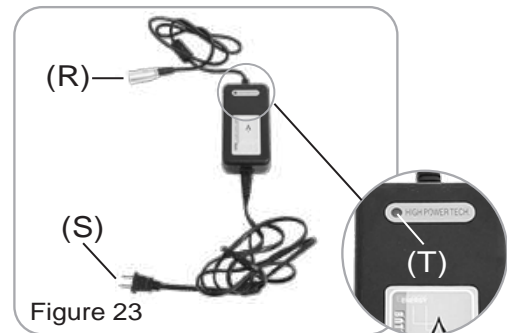



Figure 23

Lead-acid Battery Charger (Optional) :

- Output Voltage: 100V~240V (Figure 30)
 - 1.Charger output cable, 3pins  connector (U)
 - 2.AC power cord (V)
 - 3.LED Indicator(W)
 - RED LIGHT ON : Pre-charging
 - ORANGE LIGHT ON : Normal Charging
 - GREEN LIGHT ON: Fully Charged.
 - 4.2A charger takes 7 hours for a full charge. Remove the AC plug first after charging.

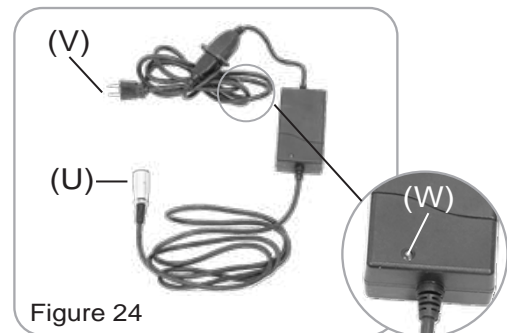

Figure 24



- Each country may supply different charger. The charging procedure may be different from below. Chargers for lithium battery and lead-acid battery (optional) are different.
- The charger LED light should indicate red when pre-charging. If not, please contact your authorized dealer.
- Inspect the battery charger before each use, make sure connectors are dry and clean. Do not attempt to use an extension cord to plug in your battery charger.
- Do not use other brand of charger to charge the scooter, only use the charger equipped with originally
- The battery charger is equipped with cooling fan. If the fan does not appear to be working correctly, please turn off the charger immediately as it may be overheated. Please contact your authorized scooter dealer.
- Do not leave charger plugged into your scooter with charger switched off as this may discharge your batteries. Always unplug the cables when finishing charging.
- Be aware that the battery charger case may become hot during charging. Please avoid skin contact.
- Keep the charger stored in a well-ventilated area, do not drop the charger.

Charging Operation :

There are two charging ports, one is on upper of scooter, and the other is on battery box. Upper Charge Port (Figure 25)

- Open the charge port cap

1. Insert the charger output cable into the charge port
2. Plug the AC cord into a standard electrical outlet on the wall
3. Check the charger LED indicator; make sure it's in normal charging. During charging, LED will indicate orange light.
4. When unplug, please make sure to remove the AC cord from the wall first, and then charger output cable from the charge port.

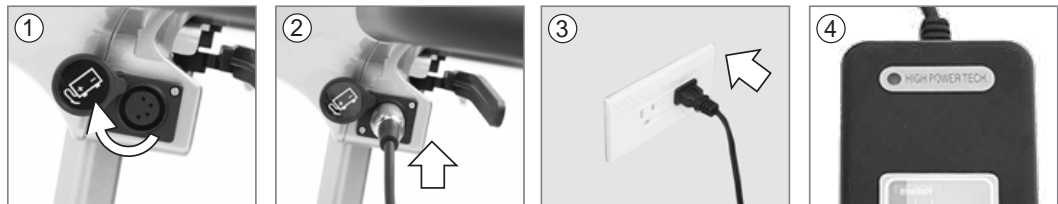

Figure 25

- Battery Box Charge Port (Figure 26)

1. Remove the battery box from the scooter and place it on a flat ground.
2. Open the charge port cap and connect the charger output cable into the charge port
3. Plug the AC cord of charger into a standard electrical outlet
4. Check the charger LED indicator; make sure it's in normal charging. During charging, LED will indicate orange light.
5. When unplug, please make sure to remove the AC cord from the wall first, and then charger output cable from the charge port.
6. put the cap back to cover charging port before install the battery box back to scooter.

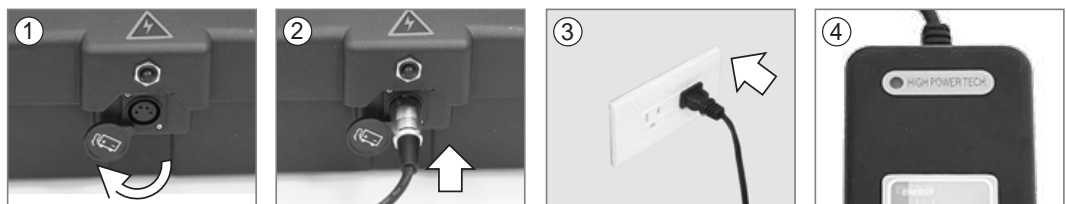

Figure 26



- The operation for charging lead-acid battery is the same as Lithium battery. Please follow the same steps as above.
- Be sure the scooter power is in the OFF position when charging.
- The time needed to recharge will vary depending on the depletion of the batteries. Charging for longer than necessary will not harm the batteries. It cannot be over-discharged.
- When remove / install the battery box, please make sure the connectors are in sequence and in position to avoid electric damage.
- Please keep the above cautions in mind. Any battery / charger faults due to the unauthorized maintenance, dismantle, misuse or accidental damage is not covered by the manufacturer's warranty
- Do not alternatively use lead-acid charger to charge lithium battery, they are not compatible and may cause damages and dangers if doing so.
- If there is any malfunction can't be resolved, remove the battery before having dealer for repair to avoid deep battery discharge. (see section 7-2)
- Please refer to battery warning instruction label 14 in section 2-7 for Lithium battery storage cautions to avoid damage or shorten the battery life.
- Recommended operating temperature :
Charge : +10°C ~ +50°C, Discharge : -20°C ~ -60°C

7.CARE AND MAINTENANCE

7-1 INSPECTION CHECKS

Daily Check :

Please always check your scooter before you start your every journey.

Check point	Inspection	What to do if the inspection is failed
N-D lever	Check for correct function.	Contact your dealer.
Horn	Check for correct function.	Contact your dealer.
Throttle Lever	Pull the wigwag to test the scooter movement. Pull the wigwag a little bit and release it to test if brake works.	Contact your dealer, the electromagnetic brake should be clean by brush regularly.
RF Remote control / folding-unfolding buttons on scooter (auto version)	Check if Remote control for folding / unfolding works. Check if folding / unfolding buttons on scooter works.	<ul style="list-style-type: none"> Replace the battery for remote control. Contact your dealer.
	Check for correct RF function.	Change battery (3Vx1pcs) or contact your dealer.
Folding / unfolding Release lever (manual version)	Check if folding / unfolding function is normal	Contact your dealer.
Battery Gauge	Check if the battery gauge is displayed and whether it is at low power.	<ul style="list-style-type: none"> Contact your dealer if battery gauge is not working. Recharge the battery immediately if low.
Battery box	Check if there is cracks or damage, and if it's firmly installed to the scooter.	Contact your dealer
Lighting	Check if all lights, such as head lights, rear lights, and turn signal are functioning correctly.	Contact your dealer.

WEEKLY CHECK

Check point	Inspection	What to do if the inspection is failed
Armrests	Check if the parts are clean and firmly tighten to the scooter and do not wobble. Tighten the screw knob that holds the armrest.	Contact your dealer.
Wheels / Tires	Check if the tire has cracks, deformation, and check that wheels rotate without wobbling. Tire tread depth is not less than 0.5mm. No foreign objects in tires.	Contact your dealer.
Motor	Check for correct function, no noisy sound, malfunction or overheat.	Contact your dealer.
Battery Charger	Check if the charger is functioning correctly and the batteries are charged.	Contact your dealer.

MONTHLY CHECK

Check point	Inspection	What to do if the inspection is failed
Seat / Upholstery / armrest	Check for movement and seat lock and if upholstery is worn.	Fasten the screws if it's loosen Contact your dealer if upholstery is worn.
Tiller fixation	Check for all fasteners	Contact your dealer

EVERY SIX MONTHS CHECK

Check point	Inspection	What to do if the inspection is failed
Electronics	Check if all the battery cables and connectors are firmly tighten to the scooter.	Contact your dealer.

Please take your scooter to a qualified technician for a thorough inspection and servicing every six months.

7-2 CLEANING AND MAINTENANCE

- User should inspect the scooter regularly to keep scooter in good running order.
- User should inspect the scooter more often especially when the scooter has possibly been riding on the bad road condition such as, grass, sand, bumps, and potholes.
- Please turn off the scooter and make sure the lever is in D position before inspection to avoid roll-away.
- Please avoid any tapping error on remote or scooter for folding/unfolding when carrying the maintenance work.
- Do not use any abrasive or scouring liquids for cleaning. Only use a damp cloth and gentle detergent.
- Do not use hose pipe or splash water directly onto the scooter as this may cause damage to electronics.

Seat Upholstery :

Only use damp cloth and a mild soap to wipe the seat. Do not use abrasive cleaners as this will damage the seat. Do not sit until the seat dries out.

Frame / Shroud :

Only use damp cloth to wipe. Do not use abrasive cleaners as this will damage the parts. When scooter dries out, the shroud can be applied with a light of wax to keep its gloss.

Tire :

Only use damp cloth to wipe. Do not use abrasive cleaners as this will damage the parts. User should inspect the tires frequently for damage, the presence of foreign bodies, unusual wear and sufficient tread depth. If replacement of tires are needed, please contact the nearest dealer.

The following areas require periodic inspection : Tread depth drops below 0.5 mm.

Storage :

- If store the scooter in long time (one week or more), please disconnect the battery terminals and do not connect battery terminal [+] [-] with any metals to avoid danger.
- When store scooter, make sure the power is off, seat lock is fixed, and N-D lever is in D position to engage brake to avoid roll-away.
- Please store the scooter in a dry location. Do not store your scooter where it will be exposed to source of direct heat, damp, oil, acid, alkaline, or where Ozone could be possibly generated. All of the above will minimize scooter / tire cycle and shorten its lifetime. Recommended range of storage for the scooter is as below :
- Temperature (with lithium battery) : Less than 1 year : -20°C ~ 20°C
Less than 3 months : -20°C ~ 40°C
Less than 1 month : -20°C ~ 50°C
- Temperature (with lead-acid battery) : -30°C ~ 50°C
- The highest temperature during battery transportation should be lower than 60°C
- If the storage environment is out of the range, we suggest you to take out the battery box from scooter and store it respectively.

All maintenance and repair of scooter MUST be done by an authorized dealer. ANY unauthorized adjustments, repair or service to the scooter may result injury to yourself or damage to scooter.

8.TROUBLE SHOOTING

Here are some suggestions about solving problems you may have with your scooter. There is a self-diagnostic warning light on the control panel. To check the self-diagnostic warning light, turn on the power (see section 4-2) and count the number of blinks on the warning light.

Touch Screen version :

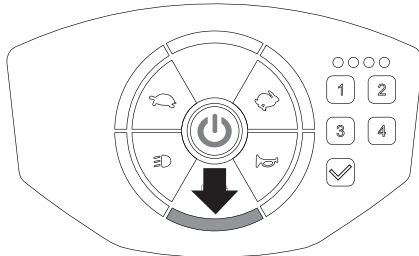

Figure 27 Normal : Solid light
Abnormal : flashing light

Key Switch Version :

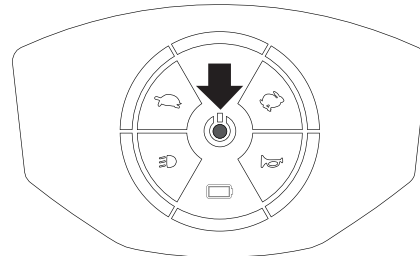

Figure 28 Normal : Solid light
Abnormal : flashing light

Self-Diagnostic Warning Light

Flash	Description	Initial check points
1	Battery Low	The batteries are running low. • Recharge the batteries.
2	Low Battery Fault	The batteries have run out of charge. • Recharge the batteries. • Check the battery and associated connections and wiring.
3	High Battery Fault	Battery voltage is too high. This may occur if overcharged and/or traveling down a long slope. • If traveling down a slope, reduce your speed to minimize the amount of regenerative charging.
4	Current limit time-out or controller overheat	The motor has been exceeding its maximum current rating for too long. • The scooter may have stalled. Turn the controller off, leave for a few minutes and turn back on again. • The motor may be faulty. Check the motor and associated connections and wiring. (see section 2-4)
5	Park Brake	Either a park brake release switch is active or the park brake is faulty. • Check the park brake and associated connections and wiring. • Ensure any associated switches are in their correct positions. • Switch to D (drive) position. Turn off the power and turn on again.
6	Drive Inhibit	Either a stop function is active or charger inhibits or OONAPU condition has occurred. • Release the stop condition (seat raised etc.) • Disconnect the battery charger. • Ensure the throttle lever is in Neutral when turning the controller on. • The throttle lever may require re-calibration. • The folding/unfolding procedure is uncompleted.
7	Speed Pot	The throttle lever, speed limit pot. SRW or their associated wiring may be faulty. • Check the throttle lever and speed pot and associated connections and wiring.
8	Motor Voltage	The motor or its associated wiring is faulty. • Check the motor and associated connections and wiring.
9	Other Error	The controller may have an internal fault. • Check all connections and wiring.

- If self-diagnostic warning lights with 1 / 2 / 4 / 5 times, please refer to above for solutions (turn off and restart again or charge the battery). If none of above correct problem, contact your authorized dealer.
- If self-diagnostic warning lights with 3 / 6 / 7 / 8 / 9 times, please contact your authorized dealer directly.

Folding / Unfolding Errors :

Here are some suggestions about solving problems you may have when folding / unfolding your scooter. The scooter will stop the folding / unfolding actions if errors are detected. Please refer to below table and correct the problems.



Figure 27



Figure 28

Code	Description	What to do
1	Power On	Please turn off the power of scooter (see section 4-2) and restart the folding / unfolding procedure.
2	Battery Low	The batteries are running low. Recharge the batteries and restart the folding/unfolding procedure. (see section 6-4)
3	Seat springs fall off	Please contact your dealer.
4	Seatback is not flipped down	Flip down the seatback and restart the folding / unfolding procedure.
5	Scooter is not on flat ground	Scooter cannot be folding/unfolding if it's not placed (lay down) on a flat ground. Please place the scooter on a flat ground and restart the folding / unfolding procedure.
6	Foreign Object on footplate.	Check and remove the object on the footplate and restart the folding / unfolding procedure.
7	Foreign Object underneath the seat	Check and remove the object underneath the seat and restart the folding / unfolding procedure.
8	Folding / unfolding light indicator on scooter is not in orange (auto version)	Auto version: please wake up the folding / unfolding function (see section 5)
	Folding / unfolding Release lever is stuck (manual version)	Hold and pull the seat base backwards with one hand while pulling the release lever with the other hand.

• If none of above correct problem, contact your authorized dealer. Do not disassemble the scooter by yourself.

9. OTHER INFORMATION



9-1 Options

We offer below options to add functionality for your scooter, please contact the authorized dealer for more information.

- We reserve the rights to modify or change the accessories.
- Please read through the cautions for battery and charger (section 6) if optional lead-acid battery is purchased.
- Scooter folding / unfolding process may be interfered with optional accessories (armrests, bags) equipped. Please remove these accessories before folding / unfolding the scooter.



Figure 29

	Item	Qty	Description
01	Bag (Front)	1	Anti-splash, max. loading weight of 2Kgs. To be installed on the front tiller.
02	Adjustable Armrests	2	Multi-Adjustable with height and flip angles.
<p>Angle adjustment</p> <ol style="list-style-type: none"> 1. Hold the armrest and pull up the latch. 2. Press downward the armrest. 3. Flip the armrest backward to the proper angle. <div style="border: 1px solid black; padding: 5px; display: inline-block;"> <p>When flip the armrest backward, it is not in locking position. Please move the armrest back to the original position to lock.</p> </div> <div style="display: flex; justify-content: space-around;"> <div style="text-align: center;">  <p>Figure 30</p> </div> <div style="text-align: center;">  <p>Figure 31</p> </div> </div> <p>Height adjustment</p> <ol style="list-style-type: none"> 1. Press and hold the armrest latch. 2. Adjust the armrest height. 3. Release armrest latch to fix armrest in position. <p>Fixation</p> <p>Use screw knobs for armrests fixation.</p>			
03	Bag (underneath the seat)	1	Anti-splash, max. loading weight of 2Kgs. To be installed underneath the seat.
04	Seat Belt	1	To be installed for extra safety.
05	Bag (seatback)	1	Anti-splash, max. loading weight of 2Kgs. To be installed on the seatback.
06	Lead-acid Battery Pack	1	With lead-acid battery (12A x 2 pcs) comes with 24/2A lead-acid charger(Do NOT use it on lithium battery) Charging port for lead-acid charger : 3 ports
07	Lithium Battery Pack (bigger capacity 17.4AH)	1	With bigger 17.4Ah lithium battery, comes with 24V/4A lithium charger. (see item 8 for charger details)

08	Lithium Battery Charger (bigger capacity 24V/4A)	1	To be used on (17.4Ah x 1pcs) lithium battery pack, can be used on 11.6Ah lithium battery also. However, do NOT use it on lead-acid battery.
<ul style="list-style-type: none"> • Charging port for lithium charger : 4 ports • Power Light : Red (power on) • Charge Light : Red (normal charging) / Green(fully charged) 			 <p>Figure 40</p>
09	Compact Armrests	2	Compact armrests adjustable with flip angle. Use screw knobs for armrests fixation.

10. TECHNICAL SPECIFICATIONS

Specification	Manual-Folding
Overall Length	Folded : 780 mm Unfolded : 955 mm
Overall Width	Folded : 515 mm Unfolded : 515 mm
Overall Height	Folded : 540 mm Unfolded : 955 mm
Front Wheels	200 mm
Rear Wheels	200 mm
Weight W/ Batteries	30 kg
Max. Speed	8 kmph
Weight Capacity	115 kg
Ground Clearance	45 mm
Grade Climbable	6 degree
Curb Climbable *	50 mm
Turning Radius	1140 mm
Brake	Electro-Mechanical
Seat Type	Padded Foldable
Seat Width	420 mm
Motor Size	250W, 4600 r.p.m
Battery Size Lithium-ion	(1) 25.2V. 11.6Ah (17.4Ah Option)
Weight of Battery Pack	2.8 kg
Travel Range **	15 km
Battery Charger	2A Off Board
Electronics	On / Off Button, Battery Level Indicator, Speed Control Buttons

※ Subject to change without notice. (Rev. 3, 2020/07/21)



MANUFACTURED AND IMPORTED BY:

AIDACARE PTY LTD.

Building 3A, 1 Moorebank Avenue,

Moorebank NSW Australia 2170

1300 133 120 | www.aspirecare.com.au