



AC SERIES BEDS

USER MANUAL



Code	Model
BEB045900	Single – 3 Function
BEB045905	King Single – 3 Function
BEB045901	Single – 2 Function

Thank you for choosing this Aidacare
AC Series Bed.

This product has been specifically designed to
offer comfort, support and safety.

**It is important that you read this user manual
carefully before using your new bed.**

TABLE OF CONTENTS

1. Introduction	4
2. Safety Precautions	5
3. Electronic Functions	7
4. General Bed Operation	9
5. Specifications	14
6. Cleaning	16
7. Maintenance	17
8. Transportation and Storage	18
9. Accessories	18
10. Warranty and Service	19

1. INTRODUCTION

The Aidacare AC Series Bed is an electrically operated Care Bed. It has a range of functions and positional movements that assist caregivers and provide for patient comfort. Ease of use, functionality, serviceability and cleaning practicality are key features of the bed. The bed has a fabricated steel structure with a powder coated finish. The plastic components are made from urethane, PP and POM nylon and ABS plastic.

Clinical Applications and Area of Use

The bed is appropriate for adult patient care under supervised medical monitoring.

Key Features

- Maximum safe working load (SWL) of the bed is 220kg
- Electrically adjusted height range of 285mm to 685mm
- 125mm diameter twin castors with central locking brakes and steering or single total lock castors (standard on AC2 series).
- Four section electrically operated mattress platform with independent adjustment of backrest angle (maximum 75°) and knee section angle (maximum 35°)
- Soft contoured mattress retainer handles
- Integrated foot end extension. Extends the bed by 195mm
- Clamp on $\frac{3}{4}$ length folding side rails (optional accessory)
- Removable bed ends
- Wall protection system

2. SAFETY PRECAUTIONS

It is **important** that this User Manual is read in its entirety prior to operating the bed. The manual is designed to ensure that users are equipped with the information required to competently and responsibly operate the bed and its accessories.

It is recommended that the User Manual be kept in an easily accessible place for quick reference. If required Aidacare product specialists can provide additional training.

All warnings and cautions within this manual should be strictly adhered to. Failure to do so could result in harm to the patient or operator.

Warnings highlighted throughout this manual identify possible hazards in procedures or conditions which if not followed correctly could result in serious injury, or fatality.

Cautions highlighted throughout this manual identify possible hazards in procedures or conditions, which if not followed correctly could result in equipment damage, or failure.

GENERAL

- Electrical equipment can be hazardous if used incorrectly.
- Residual current devices (RCD) are not supplied with the AC Series beds. Please consult with your Biomedical Engineer/advisor concerning RCD requirements.
- The clinically qualified person responsible should consider the age, size and condition of the patient before using the bed and its accessories.
- The maximum safe working load of the AC Series beds of 220kg includes the mass of the patient, mattress and any accessories fitted to the bed.
- Maximum mattress thickness that can be used on the AC Series beds is 170mm.
- Side rails must only be used with a mattress of appropriate size, which is approved for use with the bed.
- If a patient's condition could lead to a possible entrapment the mattress support platform should be left in the flat position whilst unattended.

- **ALWAYS** position the bed at its lowest height when unattended by caregivers to minimise the risk of patient injury from falls when getting in and out of the bed.
- **ALWAYS** use a mattress of appropriate size and type. A range of suitable pressure reducing and pressure relieving mattresses are also available from Aidacare.
- **ALWAYS** make sure that the patient is safely positioned to avoid entrapment before operating the bed.
- **ALWAYS** ensure that attendant and patient limbs are free from potential entrapment areas before operating any functions.
- **ALWAYS** ensure that the bed is at a suitable height to avoid stooping or straining before transporting.
- **ALWAYS** apply the brakes when the bed is stationary.
- **ALWAYS** store the handset when not in use to avoid accidental operation of the beds functions. The handset can be stored by hooking it on to the side rail of the bed.
- **ALWAYS** ensure that all hospital lines and power cables are free from possible entanglement with mechanical parts of the bed.
- **DO NOT** place the handset, or power cord across the mattress surface of the bed when the bed is not connected to mains power. Always store the power cord within the power cord fixtures fitted to the bed.
- **DO NOT** use electrically operated beds in operating theatres.
- **DO NOT** use electrically operated beds in the presence of flammable gases.
- **DO NOT** use the bed to support more than one patient. AC Series beds are intended for single person use and may become unstable if used incorrectly.
- **DO NOT** use accessories that are not designed, or approved for use with AC Series beds.

3. ELECTRONIC FUNCTIONS

WARNING

- Ensure that the patient, caregivers and or other equipment is not positioned to become either trapped or crushed during bed adjustment.
- Ensure that the coiled power lead is not stretched excessively.
- Ensure that the handset and electrical supply cables cannot become entangled with moving parts of the bed.
- DISCONNECT the electrical power cable from the mains and store before transporting the bed.
- If the power cable shows any sign of damage, replace immediately.

CAUTION

- Do not operate the bed controls for more than the prescribed duty cycle of the control system. (see rate load page 11)

3.1 HANDSET BUTTON OPERATION

AC Series beds are powered by three electric actuators, which are controlled by the buttons on the handset. Adjustment occurs only while a button is pressed. Adjustment will stop when the button is released, or the movement selection reaches the end of its range of adjustment.

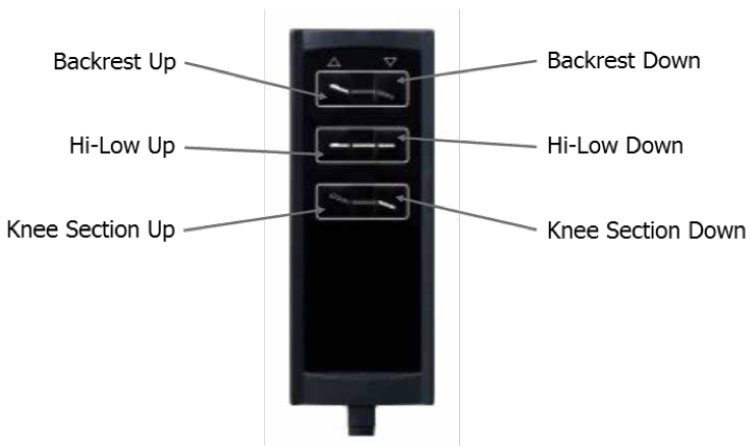

Mattress Platform Height Adjustment

To move the mattress platform up or down, press and hold the appropriate button on the handset. The platform height can be adjusted from a low of 285mm to a high of 680mm.

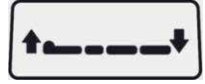

Backrest Adjustment

To move the backrest up or down, press and hold the appropriate button on the handset. The backrest can be adjusted through a range of between 0° and 75°.

WARNING: Care should be taken whilst operating the backrest function to ensure hands and fingers are free from potential squeeze hazards.



Knee Positioning Adjustment

To move the knee positioning section up and down, press and hold the appropriate button on the handset. The knee section is adjustable through a range of 0° to 35°.



3.2 BATTERY BACK-UP (OPTIONAL)

If fitted with a battery back-up unit the bed will automatically switch to battery power in the event of a power failure, or the bed being unplugged from mains power. The period of use on battery is dependent on a number of variables including weight of the user, range of movement used and age of the battery. In new condition the battery would allow for a minimum of ten to fifteen full lift cycles.

Optional Battery Back-up Unit



4. GENERAL BED OPERATION

4.1 CASTOR SYSTEM - BRAKES & STEERING

4.1.1 Central Locking Castors

AC3 Series beds have a central locking castor system that is operated with a full width foot pedal.

- With the pedal in the down **Brake** position, the brakes are applied to three castors of the bed simultaneously and the bed is immobilised.
- With the pedals in the horizontal **Free** position, the brakes are released and the bed can be moved in any direction.
- With the pedals in the raised **Steer/Track** position, one steering castor at the head end of the bed is engaged to provide better control when pushing the bed in a straight line.

Central Lock Pedal Positions:

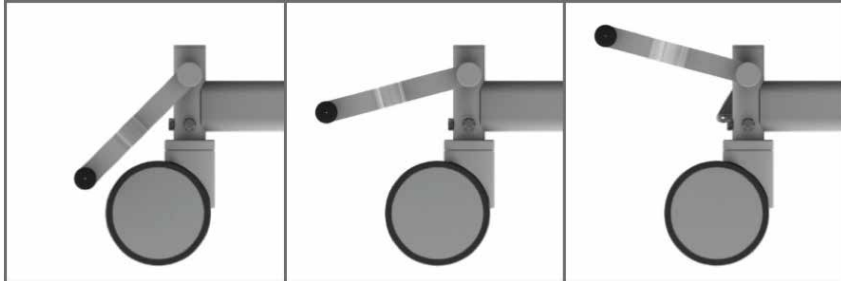

Brake

Free

Steer/Track

CAUTION:

- Disconnect the bed power cord before moving the bed.
- Do not remove the power cord from the source by pulling on the cord.
- Do not use the beds side rails to manoeuvre the bed.
- Do not pull on the power cord, or handset cord to manoeuvre the bed.
- Always apply the brakes when the bed is in a stationary position.

4.1.2 Total Lock Single Castors

AC2 Series beds have single Total Locking castors that are foot operated. These have an integrated dust cover to reduce build-up of residue.



4.2 BED EXTENSION

The integrated bed extension can add an extra 19.5cm of length to the mattress platform.

Moving Bed Extension From Closed/Standard Bed Position

1. The bed extension is held in position by two threaded hand wheels on either side of the bed. Unscrew (anti clockwise) the hand wheels on both sides. It is not necessary to remove the hand wheels completely, unscrewing them by approximately 10mm of thread length will allow for the internal lock nut to travel freely past the thread of the hand wheel.
2. With both hand wheels now unscrewed, gently pull with an even force on both sides of the panel. (2) Indicates the best position for easier extension if used on both sides of the panel at the same time.
3. The panel will stop at its fully extended length.
4. Return the hand wheels back to their locked position (1)

To reposition the panel back to the closed/standard bed position use the same technique as above.

WARNING: The bed extension is designed for use as a bed extension only and is not meant to support the body weight of a person sitting. The extra length of the bed with extra load can also make the bed unstable potentially resulting in injury to the user and patient.



4.3 FOLD DOWN SIDE RAILS (OPTIONAL)

Bed rails (optional) are easily fitted by clamping to the bed frame. When fitted correctly, AC Series bed rails meet the requirements of Medical equipment international standard IEC 60601-2-52, which includes specific rail requirements.

4.3.1 Fitting the Side Rails

NOTE: The rails are a left and right hand set and when fitted correctly fold down towards the foot end of the bed.

1. Before fitting the rails unscrew the hand wheel to bring the locking clamp into an open neutral position which will allow the rail to fit over the side rail of the bed.

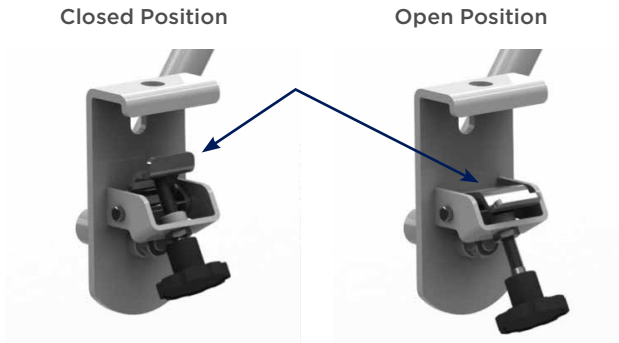

2. With both hand wheels now unscrewed, lift the rail into position. It is important that the rails are fitted to a specific position on the bed, which is indicated by the disc on the top of the side rail. Position the rail over the disc and tighten the hand wheel to the closed position.

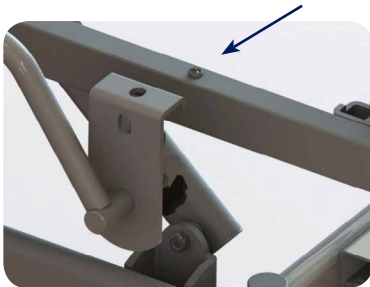

4.3.2 Side Rail Operation

The rails are either fully raised, or folded down closed. When the side rail is raised to its full height position it will automatically lock in the positioning hole on the rail clamp plate. The release/lock knob feature can be both visually and audibly confirmed.

WARNING: Do not operate side rails when there is potential of entrapment or crushing to the patient, caregivers, visitors and/or other equipment.

Side Rail Operation

To raise the side: Lift the top rail until the locating pin/knob automatically clicks into its locked position at maximum height.

To lower the side: Hold the top rail near the foot end of the bed (1) and gently pull out the red operating knob (2) lowering the side towards the foot of the bed whilst controlling the descent speed. As the side begins to be lowered the operating knob can be released.



WARNING: Care should be taken whilst operating the side rails to ensure hands and fingers are kept away from potential squeeze hazards. Side rails should only be used after clinical assessment and within organisational policy and guidelines.

4.3.3 Side Rail Safety Lock Indicator

The side rail locating pin has a yellow coating that allows for visual inspection of the locking device. When the side rail is in the raised position, viewing the release knob from the side there should be no yellow shaft visible. If there is yellow shaft visible the safety side is NOT securely locked in the upright position and needs to be adjusted.

The yellow coating should NOT be visible from above when the safety side is correctly locked in position.

Side rail release and lock knob shown in unlocked and locked positions

WARNING: After adjustment of the side rail visually check the locking pin location. There should be no yellow shaft on the locking pin visible if locked correctly. DO NOT use other manufacturer's side rails on AC Series beds.



4.4 King Single Extendable Foot End Mattress Retainer

AC Series beds can be ordered with a two position extendable foot end mattress retainer that is used in conjunction with the bed extension. This feature is included for use when a foot board is not required on the bed and should be removed when a foot board is in place.

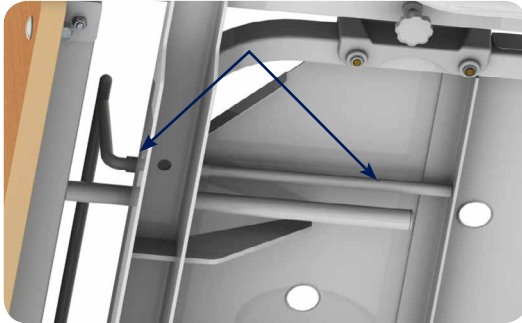

To extend the mattress retainer remove the two retaining pins and pull out until the required second set of holes are aligned. Replace the pins before use.



SAFETY NOTE:

The mattress extension retainer should not be used in conjunction with a foot board as this may create a pinch hazard.

5. SPECIFICATIONS

PRODUCT MODEL NO. BEB045900 & BEB045901

Basic Dimensions

Overall Length	2120 mm
Overall Length (including wall protection buffer)	2230 mm
Overall Width	920 mm
Overall Width (rails fitted)	1030 mm
Mattress Surface Length (between panels)	2070 mm
Bed Platform Height Range	285 mm to 685 mm
Back Rest Angle Adjustment	0° to 70°
Knee Bend Angle Adjustment	0° to 35° (AC3 Series Only)

Mattress Size

Recommended Mattress Size Maximum Mattress Depth	Width = 900 mm
	Length = 2000 mm
	Depth = 170 mm

Bed Weight & Safe Working Load

Without Side Rails	112 Kg
With Side Rails	132 Kg
S.W.L (Safety Factor 2 x S.W.L)	220 Kg

Electric Parameter

Power Input	230V AC 50Hz, Max current 1A
Rate Load	Interruption 10%, Max 2 minutes / 18 minutes
Leakage Protection	Class 1 Type B 
Waterproof Grade	IP54

Standard

Aidacare AC Series beds are designed and manufactured in compliance with International Standard IEC 60601-2-52.

PRODUCT MODEL NO. BEB045905

Basic Dimensions

Overall Length	2140 mm
Overall Length (including wall protection buffer)	2250 mm
Overall Width	1090 mm
Overall Width (rails fitted)	1200 mm
Mattress Surface Length (between panel & retainer)	2025 mm
Bed Platform Height Range	285 mm to 685 mm
Back Rest Angle Adjustment	0° to 75°
Knee Bend Angle Adjustment	0° to 35°

Mattress Size

Recommended Mattress Size Maximum Mattress Depth	Width = 1050 mm
	Length = 2050 mm
	Depth = 170 mm

Bed Weight & Safe Working Load

Without Side Rails	117 Kg
With Side Rails	137 Kg
S.W.L (Safety Factor 2 x S.W.L)	220 Kg

Electric Parameter

Power Input	230V AC 50Hz, Max current 1A
Rate Load	Interruption 10%, Max 2 minutes/ 18 minutes
Leakage Protection	Class 1 Type B 
Waterproof Grade	IP54

Standard

Aidacare AC Series beds are designed and manufactured in compliance with International Standard IEC 60601-2-52.

6. CLEANING

WARNING

Before cleaning always disconnect the bed from the mains power source.

Note: It is strongly recommended that protective clothing be used when cleaning.

Note: The following procedure also applies to the beds accessories, but does not include mattresses.

- Wipe the beds surfaces with a soft cloth moistened with hot water and mild detergent (or the facilities recommended cleaning solution). It is recommended that the cloth be a white material to prevent bleeding of die colours to the bed. Take extra care in areas that can harbour dirt or dust.
- Rinse with clean water and a dry clean cloth.
- To remove potentially infectious materials such as body fluids, or when the bed has been used by someone with a known infection. Clean with NaDCC (e.g. Presept, Actichlor) at 10,000 ppm of available chlorine. Rinse and dry.
- Allow the cleaned parts to dry before replacing the mattress.

CAUTION

Do not use abrasive Hypocarbonate or Phenolic compounds or pads.

7. MAINTENANCE

To prolong the working life of the bed and for trouble free operation it is recommended that routine inspections should be performed by a person who is suitably qualified and well acquainted with the design, use and care of AC Series beds.

If inspection reveals that the safety of the bed is jeopardised in any way, it should be **IMMEDIATELY WITHDRAWN FROM SERVICE**, tagged as such and the owner notified.

The following preventative maintenance procedures should be carried out every 12 months.

Electrical test & tag – where lifters are in use in a commercial environment then the testing regime applied should align with the risk assessment made by the owner for safety and other compliance requirements.

NOTE: Other than general maintenance activities all other service or repair work must be performed by qualified and trained persons who are approved by Aidacare.

WARNING: The bed must be disconnected from the mains power supply before starting any maintenance activity.

General	
1	Examine all the warning signs on the bed, examine the bed for obvious signs of damage. All aspects of the equipment should operate as intended. Check that all nuts, bolts and other fasteners are tight and are not missing.
2	Examine flexible cables and conduits for cuts, cracks, abrasions or other deterioration.
3	Check that the power supply plug is not damaged. If either the power cable or plug is damaged then both the cable and plug must be replaced as a complete assembly by an approved service agent.
Central Locking System	
1	Apply the brakes and push the bed forwards. If any of the four braking castors rotate the brake is not fully effective.
2	Check the two steering lock castors for correct operation.
3	If either the brakes or the steering locks are not working correctly contact an approved service agent.
Side Rails (if fitted)	
1	<ul style="list-style-type: none"> • The locking pin mechanism and striker plate arrangement should be checked every three months. • Inspect the side rails for general wear and tear on fittings and pivot joints every six months. • Check for rust, structural integrity of welds and paint finish every twelve months.
2	Raise the side rail to the upright position until the locking mechanism clicks into place. Refer to the operating procedures starting on page 10 of this manual for further instruction.
3	Check that there is no yellow shaft visible. In the locked position the red on the locking pin shaft should not be visible from above
4	If the red shaft is visible when the side rail is in the raised and locked position, contact Aidacare for service advice.
5	Check that the rails pivot axles are securely fitted to the bed. The pivot axles are locked into place by the manufacturer by a 10mm lock nut.

8. TRANSPORT & STORAGE

Handle With Care.

AC Series beds should be stored in a clean, dry, well ventilated area.

Do not drop and avoid shock or violent impact when transporting.

The following limits apply during transport and or a storage period of up to 15 weeks duration:

Ambient temperature	-25°C	To	+70°C
Relative humidity	10%	To	75%
Air pressure	50 kPa	To	106 kPa

The following limits apply to normal operating conditions and or periods of storage longer than 15 weeks:

Ambient temperature	+10°C	To	+40°C
Relative humidity	30%	To	75%
Air pressure	70 kPa	To	106 kPa

9. ACCESSORIES

A range of AC Series accessories are available. In addition to the below listed accessories, Aidacare specializes in other complimentary products such as foam mattresses, pressure care surfaces, over bed tables, side lockers and adjustable day chairs. Please contact Customer Service on 1300 133 120 for further information.

Product code	Description
BEA029700	Folding Side Rails
BEA029705	Self Help Pole – Stainless Steel (Includes Strap & Handle)
BEA029710	IV Pole (Stainless Steel)

WARNING: Do not use accessories that have not been designed for use with the AC Series beds.

7. WARRANTY & SERVICE

Aidacare AC Series beds carry a comprehensive warranty as detailed below. Please keep proof of purchase for proof of warranty commencement.

Warranty Duration:
– Frame: 10 Years
– Electronics: 3 Years
– Handsets and Cable: 1 year

Consumer Warranty Against Defects:

Aidacare is bound by Australian Consumer Law in respect to Warranty Against Defects. A copy of the Aidacare Warranty Against Defects statement is available on the Aidacare homepage at www.aidacare.com.au. All warranty matters should be directed to Aidacare Customer Service on 1300 133 120.

Aidacare does not warrant against excessive or incorrect use, modification or any situation that could not be deemed as fair wear and tear. This is a back to base warranty and does not cover freight costs pertaining to the return of any items under warranty. Aidacare acknowledges and conforms to all ACCC guidelines around consumer rights. For further information contact Aidacare on 1300 133 120 or email product@aidacare.com.au.

Aidacare will not warrant the safety and or correct functioning of products where any original components have been changed or modified by non-Aidacare approved and trained service & maintenance staff or external providers. Furthermore, safety is not guaranteed where components have been replaced with non-original Aidacare approved parts. If any faults are detected upon receipt of this product please phone Aidacare. Any faults that are detected during normal use should be reported to Aidacare immediately to determine if warranty conditions apply and if so, the necessary repair or replacement work to be completed.

Spare parts list is available upon request.

For servicing, preventative maintenance and any other questions regarding this or any other Aidacare product please contact:

Aidacare Pty Ltd
4 Noonan Rd, Ingleburn NSW 2565
T - 1300 133 120
W - www.aidacare.com.au
E - product@aidacare.com.au



Imported by:

AIDACARE P/L | 4 Noonan Rd, Ingleburn
NSW 2565

T - 1300 133 120 | W - www.aidacare.com.au